

How to do wallcoverings with HP Latex 700 and HP Latex 800 Printer Series

This document will explain how to work on different types of wallcovering substrates, including lamination and installation.

For more information, please access to the [HP Latex 700/800 Printer series – Wallcoverings](#) on the [Learn with HP website](#).



How to do wallcoverings



What you will need

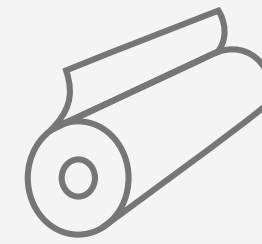
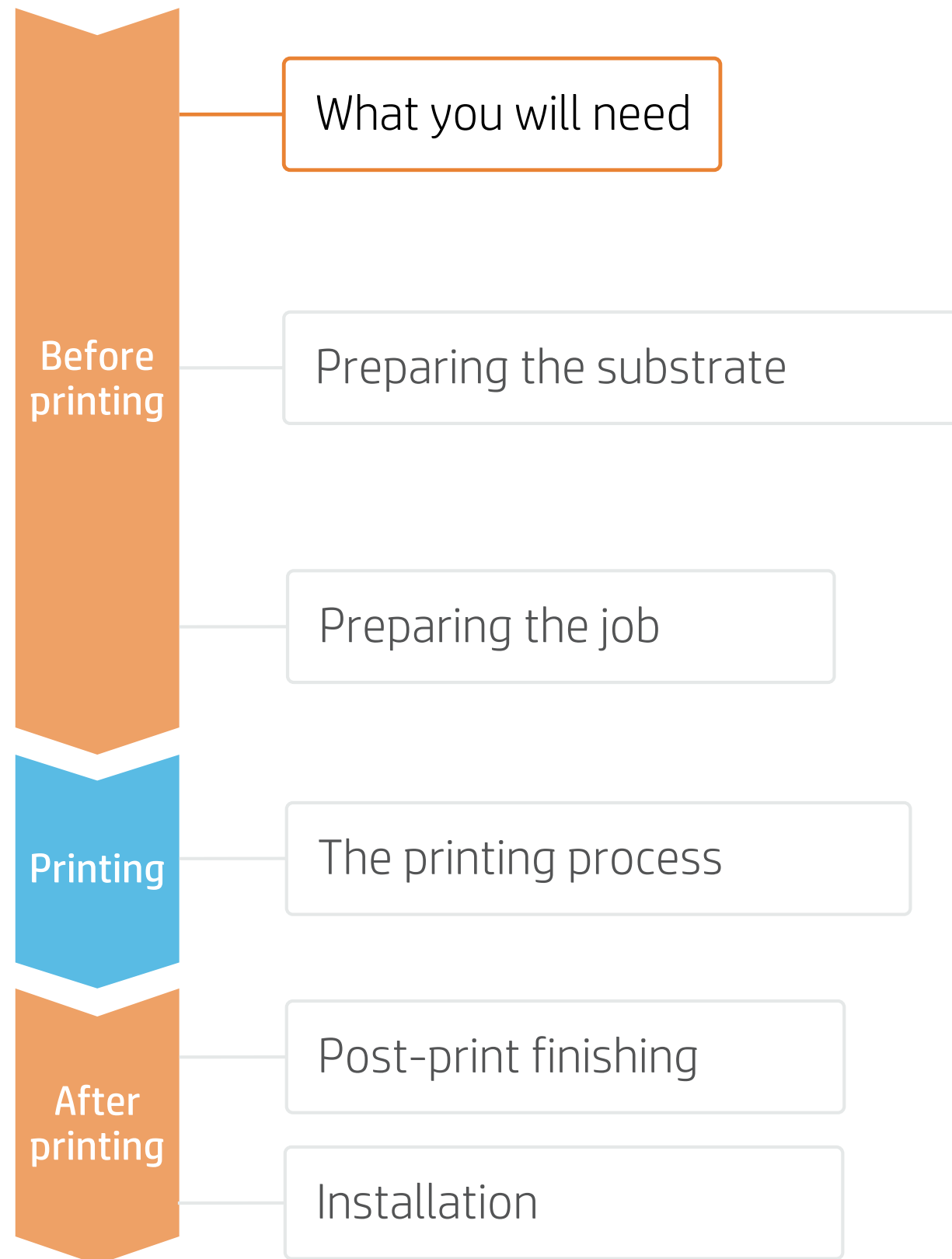

Wallcovering substrates



SW tools (RIP, Adobe tools, etc.)

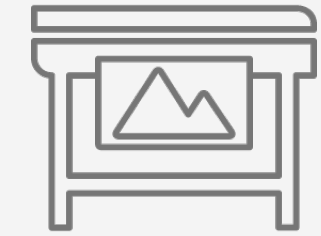

Printer

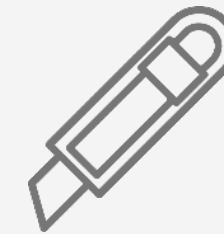

Cutting device



Precision ruler



Adhesive paste (optional)



Water + sponge

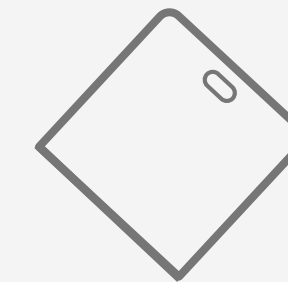

Smoothing plastic spatula or brush

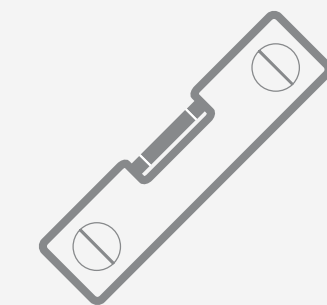

Level



Seam roller (optional)

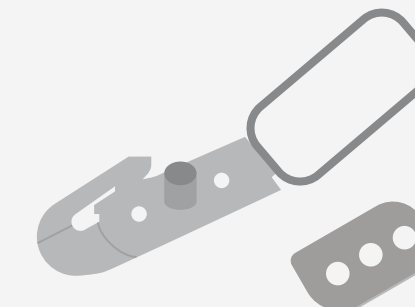

Double-cutter (optional)

How to do wallcoverings

Preparing the substrate

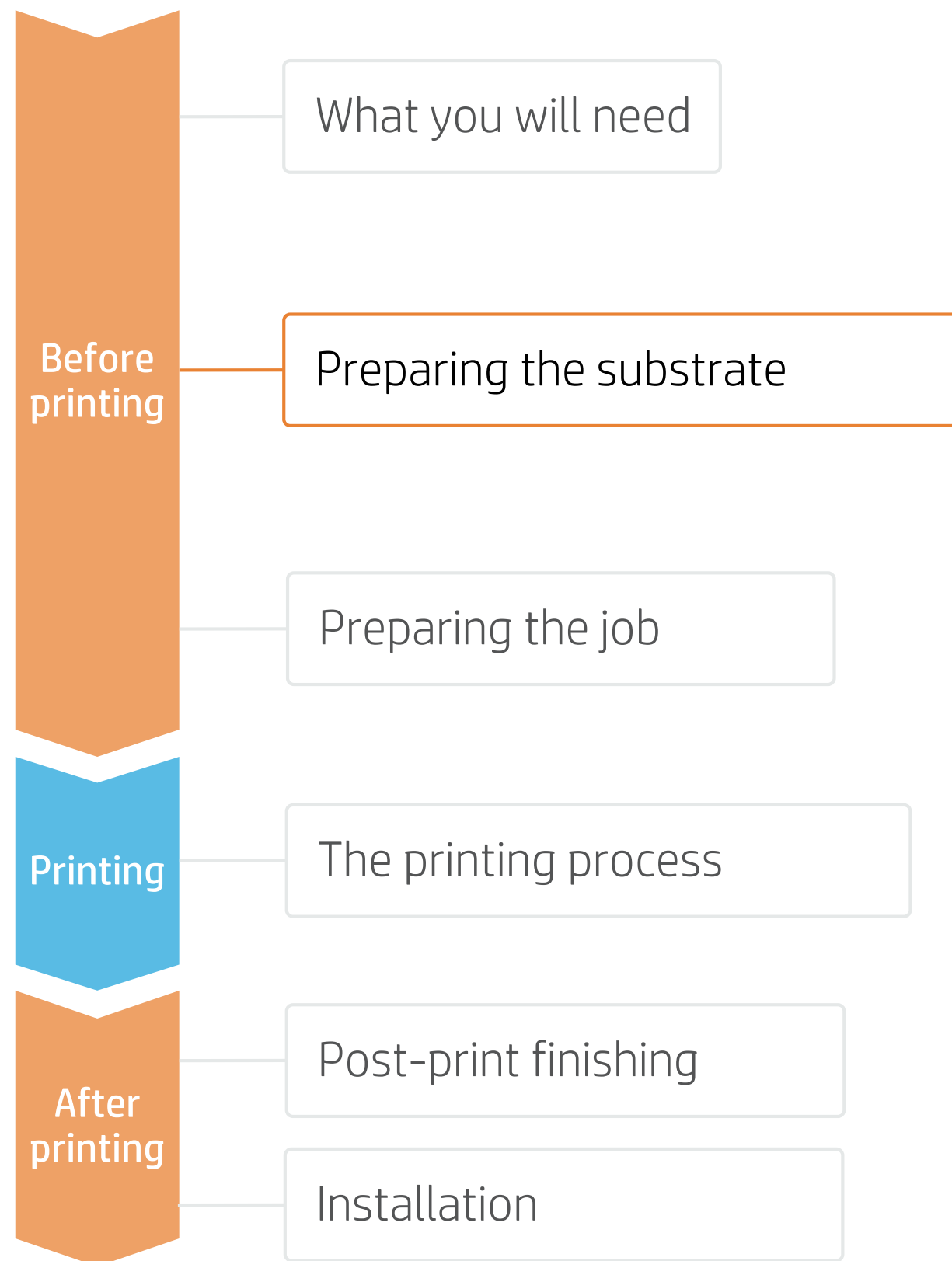

1. Choose the right substrate

- Firstly, understand the requirements of your application, whether it is **residential** or **commercial**, and the usage (room, kitchen, office).
- There are different types of wallcovering substrates based on their construction:



Make your decision based on your needs



a) Base material:

Type	Features	Adhesive Application
Paper	<ul style="list-style-type: none"> • Most economic • Dimensionally instable with humidity and water 	<ul style="list-style-type: none"> • * Apply paste to paper
Non-woven	<ul style="list-style-type: none"> • Highly strippable • Dimensionally stable when wet 	<ul style="list-style-type: none"> • * Apply paste to paper, or • * apply paste to wall
Fabric	<ul style="list-style-type: none"> • Highly strippable • Dimensionally stable when wet 	

NOTE: * Some paper or non-woven substrates might come **pre-pasted**, in which case soaking the substrate in water or wetting the wall with water are the ways to activate the adhesive.

b) Front (decorative) surface:

Type	Features	Usage
Uncoated	<ul style="list-style-type: none"> Soft touch Low degree of washability 	Residential use. Not recommended for kitchens or bathrooms.
PVC-free coated	<ul style="list-style-type: none"> High degree of washability Scrubable 	For residential or contract segments.
Vinyl	<ul style="list-style-type: none"> High degree of washability Scrubable 	Most common in contract segments. Frequently used in high traffic areas. Suitable for kitchens and bathrooms.
Textile	<ul style="list-style-type: none"> High value-added 	For residential or contract segments.

How to do wallcoverings

Preparing the substrate

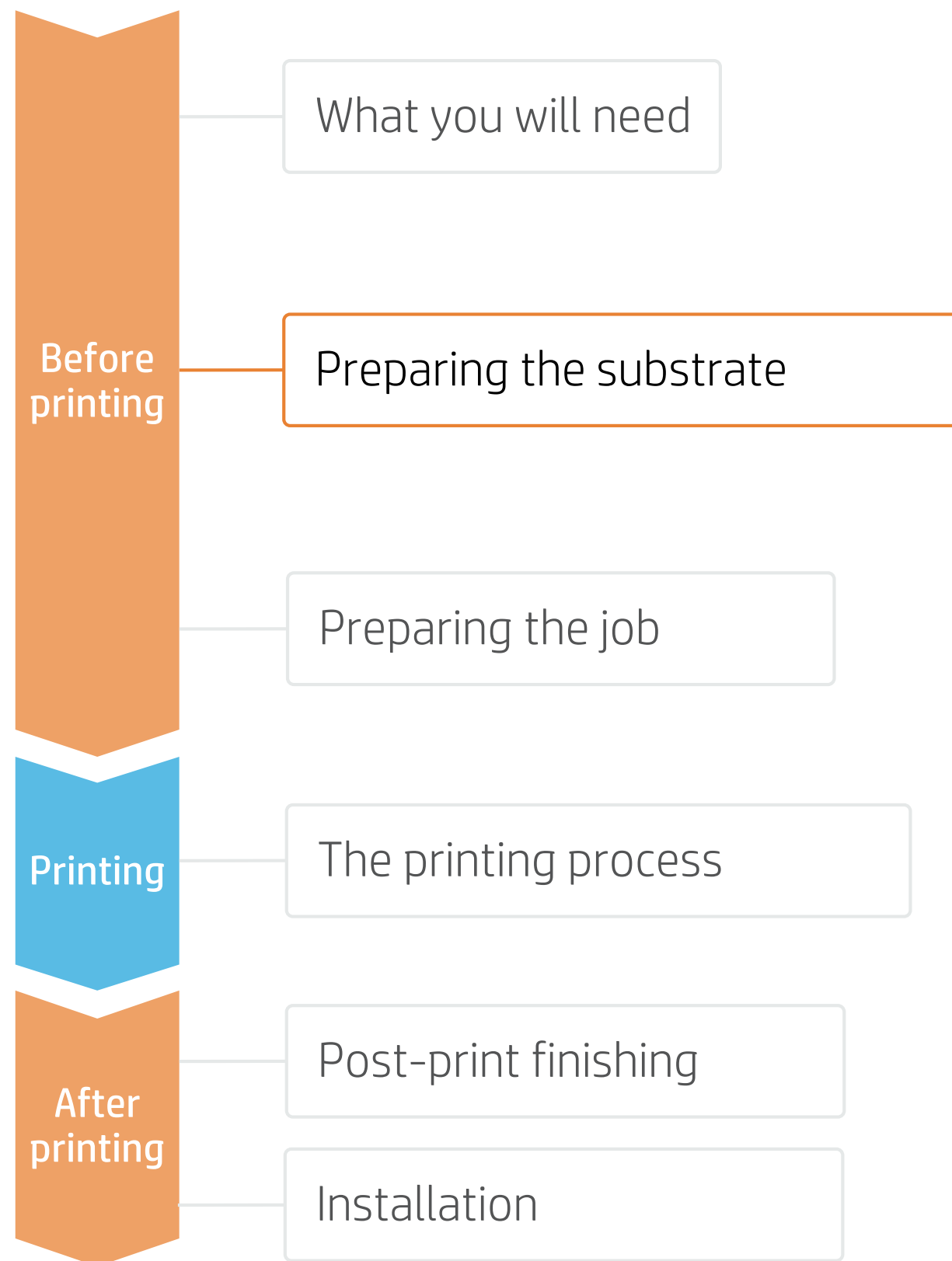

3. Substrate presets

- Check that the material you are going to use has its own substrate preset:
 - a) On the **web**, in the HP PrintOS Media Locator: www.printos.com/ml/#/medialocator
 - b) On the printer's **front panel** online search (Substrate Library)
 - c) On the **web**, from the substrate vendor's or RIP vendor's websites
- Download and install.

NOTE: If you cannot find the substrate presets, you can always use the **generic paper & wallcovering** already installed in your printer. If you need to fine-tune some settings, clone the existing generic preset and modify it, or create a new one with the **Add new substrate** function on the front panel.

TIP: Learn how to customize your profile by enrolling on the available training HP Latex 700/800 Printer series – Advanced main tasks and maintenance routines on the [Learn with HP website](#).

How to do wallcoverings

Preparing the job

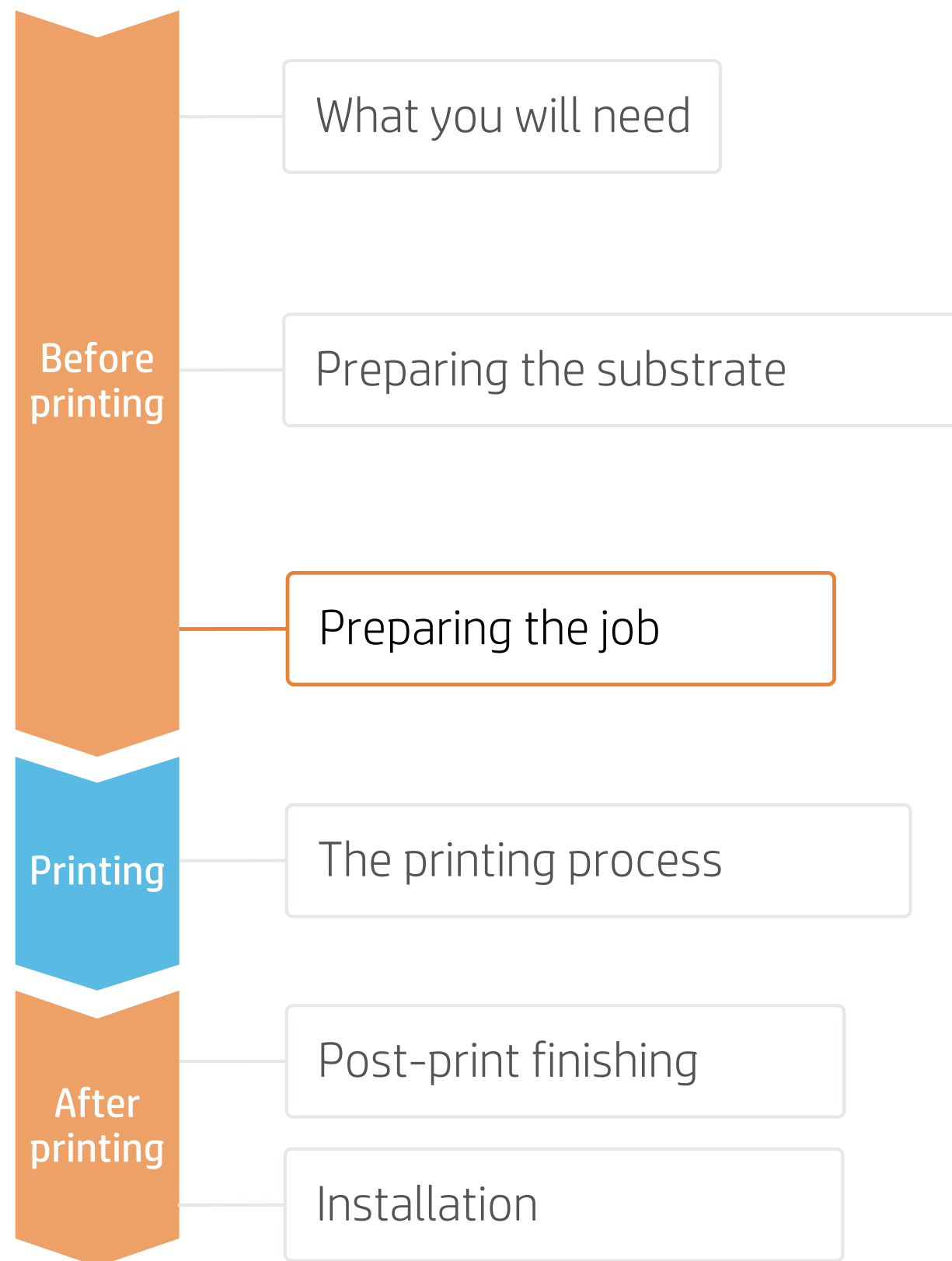

1. Software for designing and editing

Tools such as HP Application Center (HP WallArt), Adobe Illustrator, Photoshop, and InDesign help you design and edit jobs and adapt them to your needs.



Make your decision based on your needs



A. HP WallArt

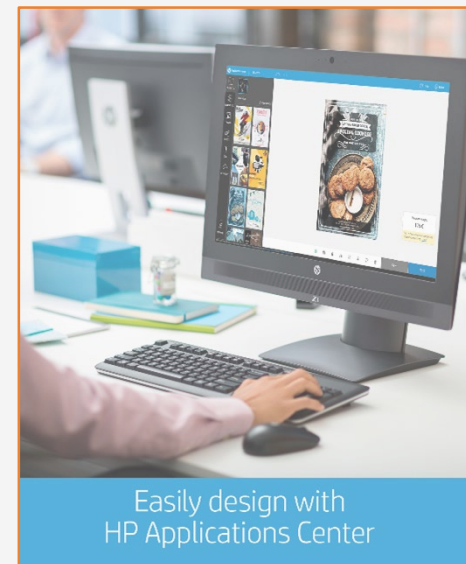

HP WallArt is part of HP Applications center, a complete package of tools to boost your business.

There is a specific application for creating wallcovering jobs.

EXPAND YOUR KNOWLEDGE: For further detailed information regarding the HP Applications center and how to log in for the first time, view the available **webinar** in this [link!](#)

How does it work?

1

Join the platform
Simple, easy sign-in with your HP printer serial number

2

Choose web app
Select the standalone decorative web apps you want to produce and allow your customers to create and visualize the design, with a simulation for each unique environment.

3

Manage orders
Manage production efficiently with automatic, reliable, print-ready PDF generation, as well as customer, order, and content management tools.

How to do wallcoverings

Preparing the job

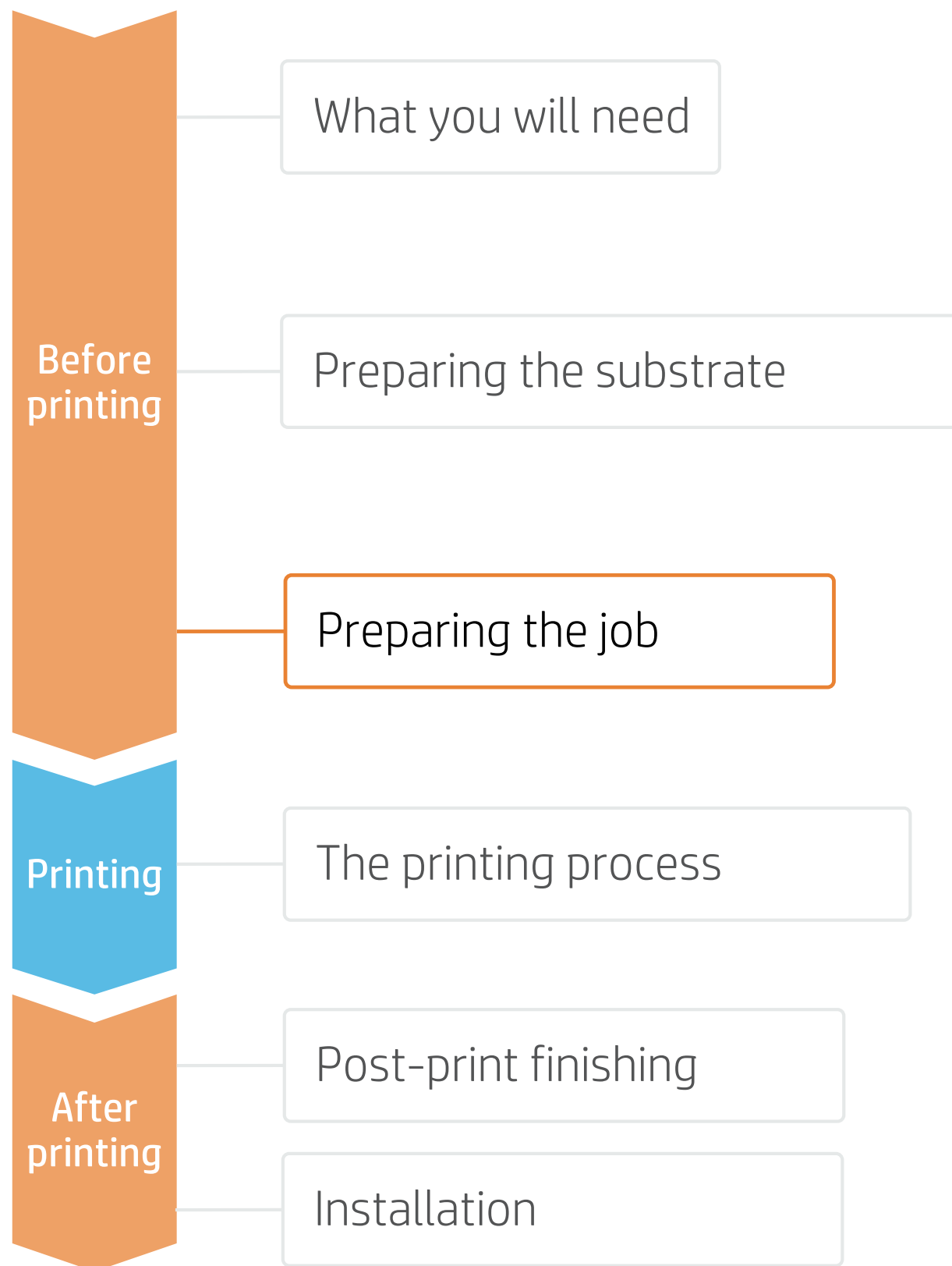

2. RIP processes

ONYX, CALDERA, and SAi RIPs have been certified for HP Latex 700/800 Printers series. All these rips have specific options for wallcovering job editing.



Make your decision based on your needs

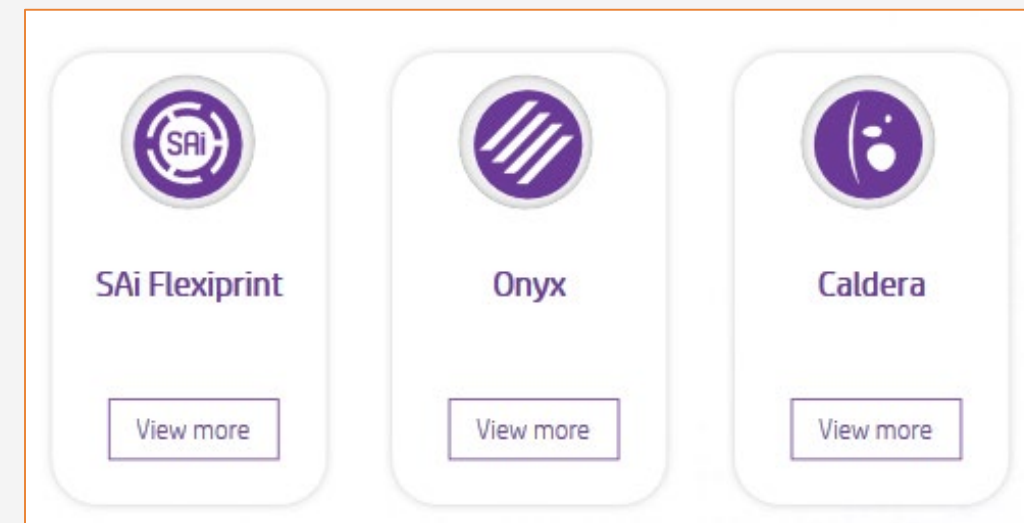

NOTE: Please refer to the specific trainings on RIPs at the PrintOS Learn App.

A. Substrate & Printmode selection

- Choose the substrate type (Paper & Wallcovering), then select the specific substrate you have loaded on the printer, or a generic preset.
- Next, choose the printmode: **8p mode** gives good quality prints with wallcoverings. For optimal color and tiling length consistency, go to **12p mode**.

NOTE: If you use a wallcovering with colored finishing and need to add **white layers**, learn how to create it with Illustrator and Photoshop by enrolling on the available training HP Latex 700/800 Printer series - White ink on the [Learn with HP website](#), or refer to the cookbook [How to print on white](#).

How to do wallcoverings

Preparing the job

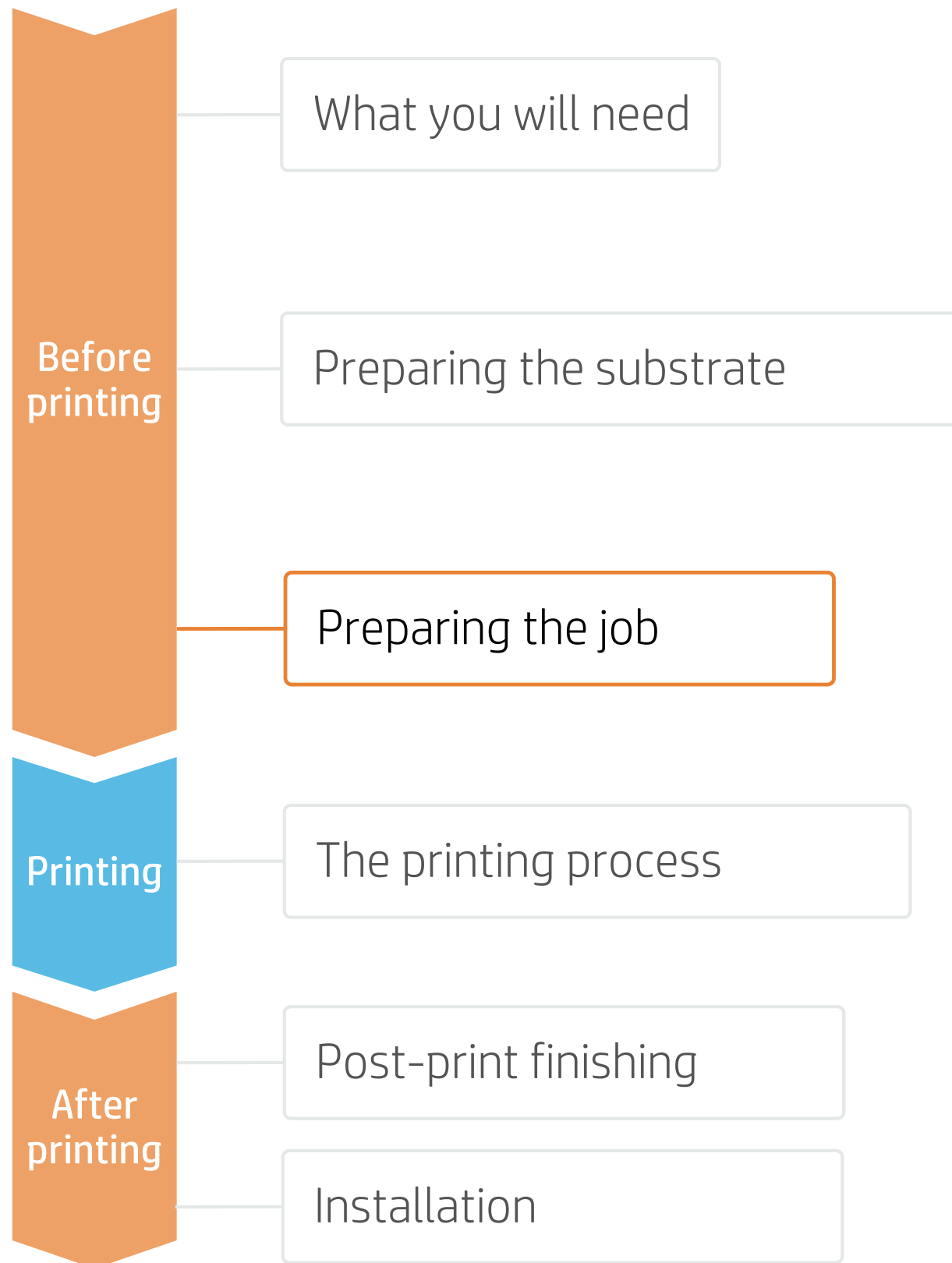

B. Image size & tiling

- Modify the image size according to the wall size and your design.

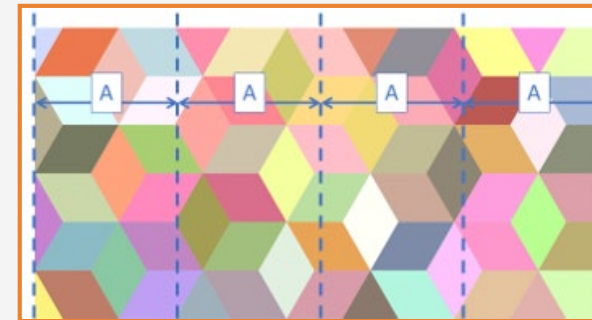

For patterns, you may choose a fixed tile **width** and assign the **number** of tiles needed to cover the wall.



For photo walls or special designs, adapt the tile width so the design is not cut off by the wall limits.



Extend the tile length at least 5cm extra on the top and bottom edges for later trimming.

- Configure the number and size of tiles.
- Add overlaps, recommended 1-3 cm, (max. 5 cm)

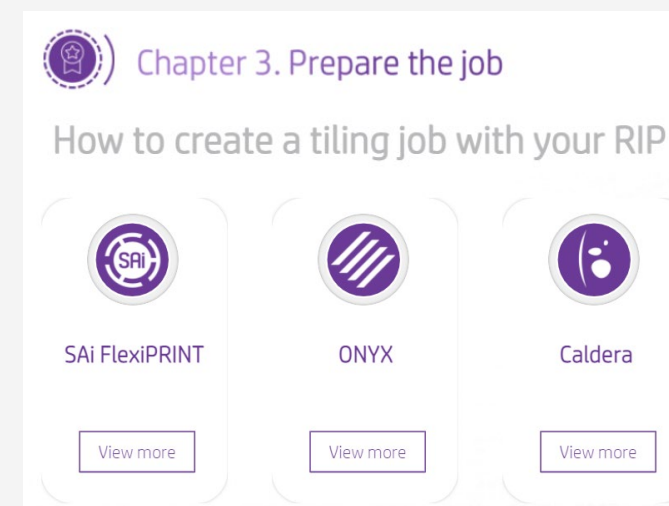

NOTE: Learn how to configure tiles in your rip by enrolling on the training available online, [HP Latex 700/800 Printer series – Wallcoverings \(Chapter 3\)](#). For further information please refer to the RIP manuals.

C. Finishing: cutting marks & others

- Select the automatic cutter you will use for cutting your jobs.
- Configure the cutting marks for that cutter: trim box, placement, and type of barcode.
- Add **labels** to identify each tile.

NOTE: Each RIP has different ways to set the cutting marks. Please refer to the specific RIP manuals.



How to do wallcoverings

Preparing the job

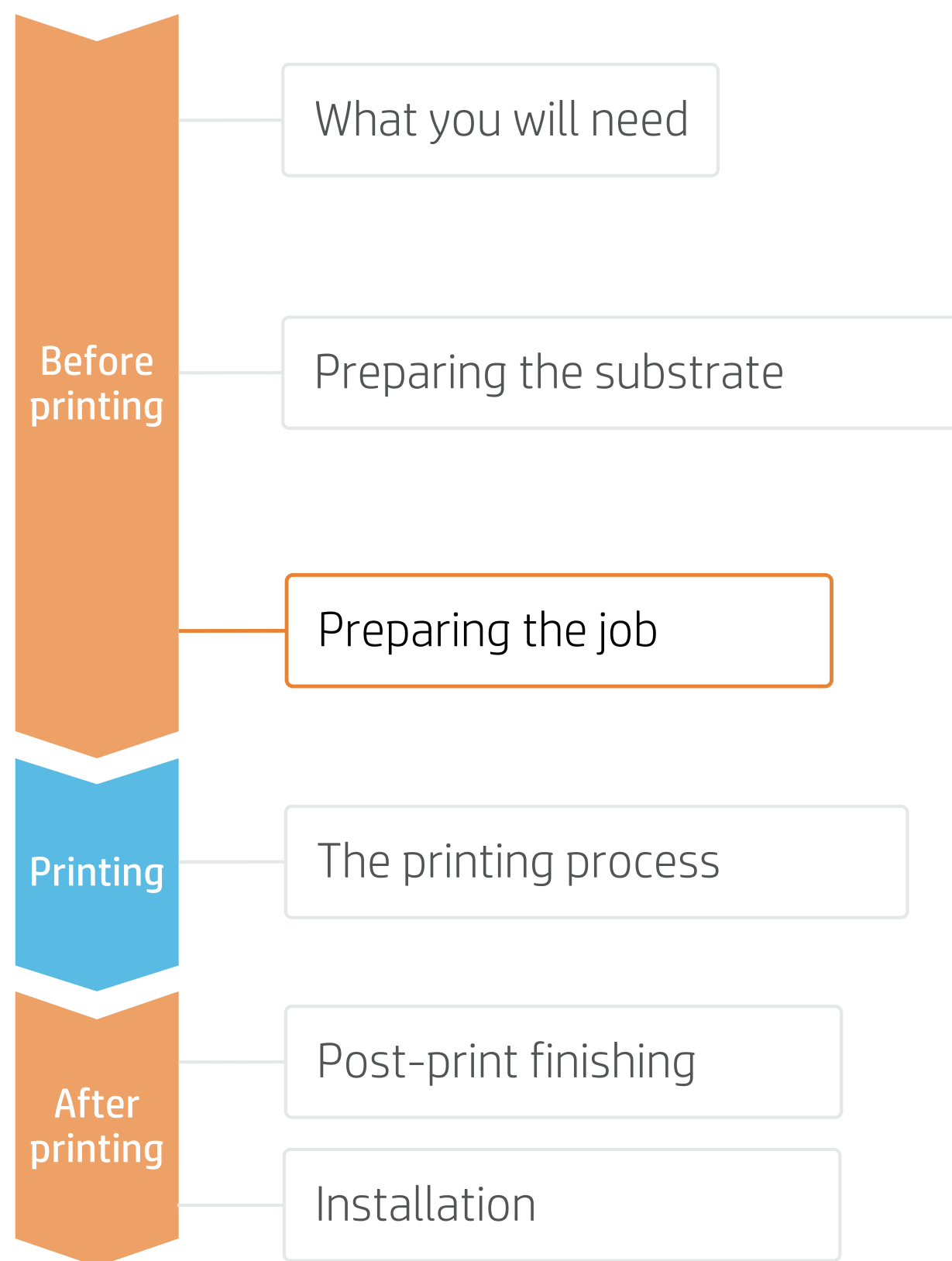

3. Tips for tiling applications

Two critical requirements for tiling applications are the **color consistency** and **length consistency** tile-to-tile.

Contiguous tiles with the same background solid color may show differences in color between the right side of the first tile and the left side of the second tile.

Also, non-uniform dimensional stability of substrates, e.g. specific banners, can lead to differences in length side-to-side. Also, the dimensions of the print will not be correct when expansion or shrinkage of substrates occurs.

A. Color consistency tile-to-tile

- Ensure that your environmental conditions are suitable for best print quality: RH 40-60%, Temp. 20-25°C.
- Start printing with substrate already attached to the TUR.
- Choose print modes of **8p or higher**, with the lowest density possible.
- Avoid printing with a **cold printer**; warm it up by printing a short job in advance: A **nozzle health check** is enough to warm up the printer.
- Invert alternate tiles, from the RIP feature.



B. Length consistency tile-to-tile

- Ensure that the substrate-advance sensor is enabled in the RIP's substrate preset
- Start printing with substrate already attached to the TUR.
- Invert alternate tiles, from the RIP feature.
- Tile together areas with similar amounts of ink. If this is not possible, print the areas with different amounts of ink as different jobs and modify the length of the job with less ink in the RIP to match its size with the job with high ink content.
- Print a sample and adjust the size of the image in the RIP accordingly.

How to do wallcoverings

The printing process

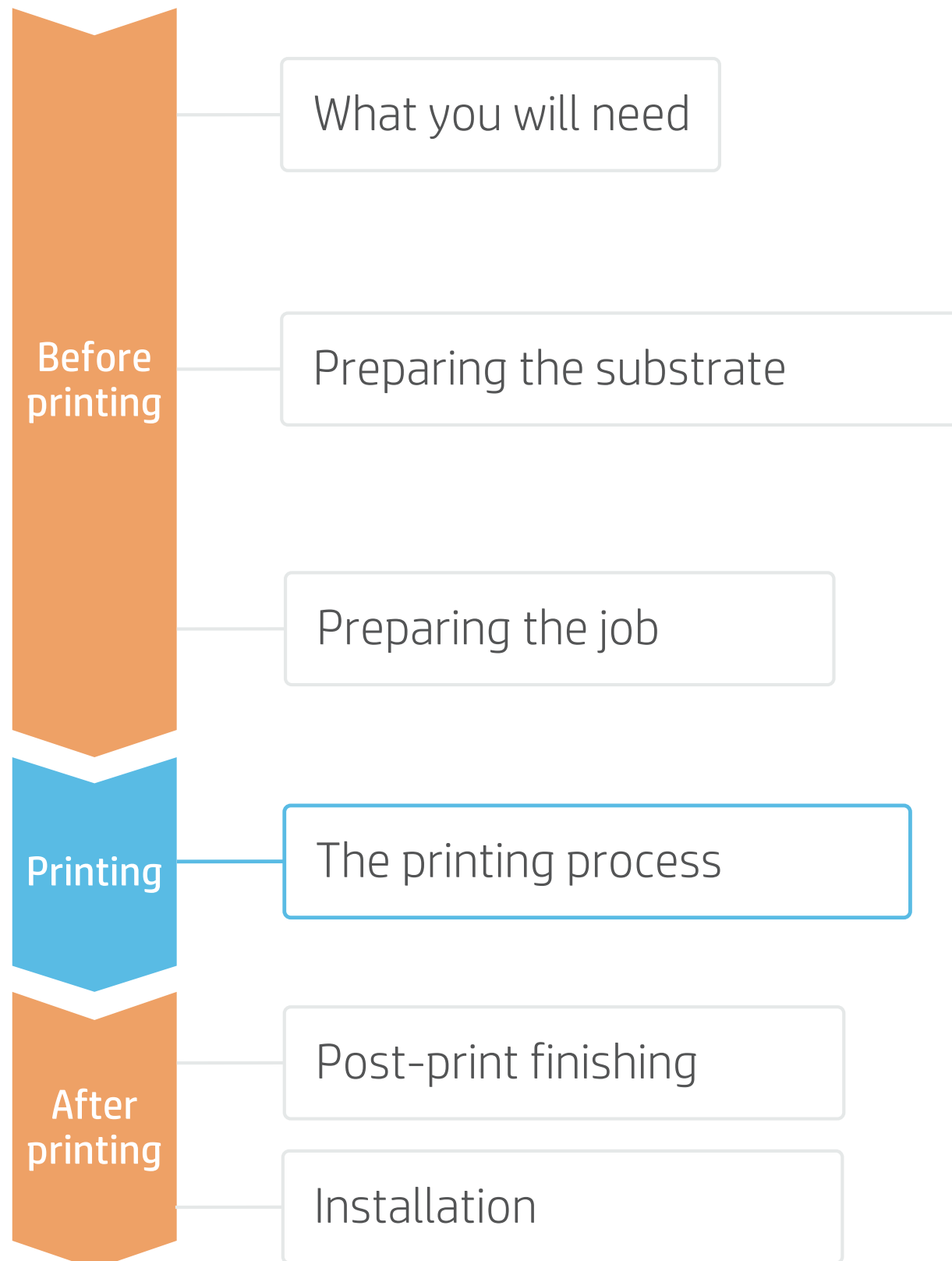

Load the substrate | Connect to the take-up reel (TUR)

- 1. Prepare the TUR**
Attach an empty core on the TUR.
- 2. Move substrate**
Advance substrate until the leading edge levels with the TUR.
- 3. Release substrate from pinches**
Lift the pinchwheels.
Align right edge of substrate with the right edge of the input roll.
Tap **Done** in the front panel to lower the pinchwheels.
- 4. Attach substrate to the TUR**
You can attach the substrate so that the printed side is **in (a)** or **out (b)** (out is most common).
- 5. Activate the TUR**
Complete a full rotation of the TUR.
- 6. Calibrate the TUR**
Select **calibrate** on the front panel.

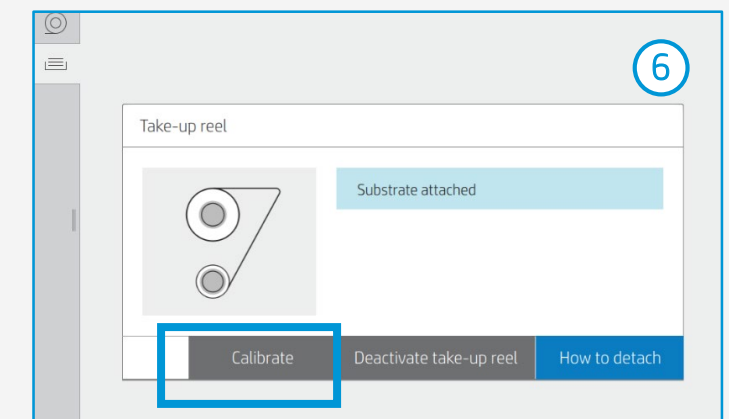
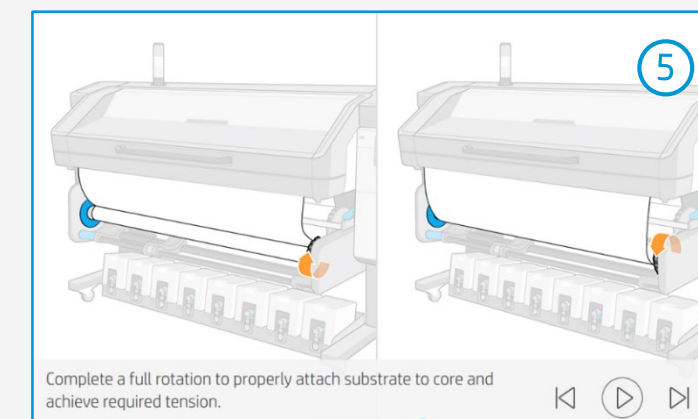
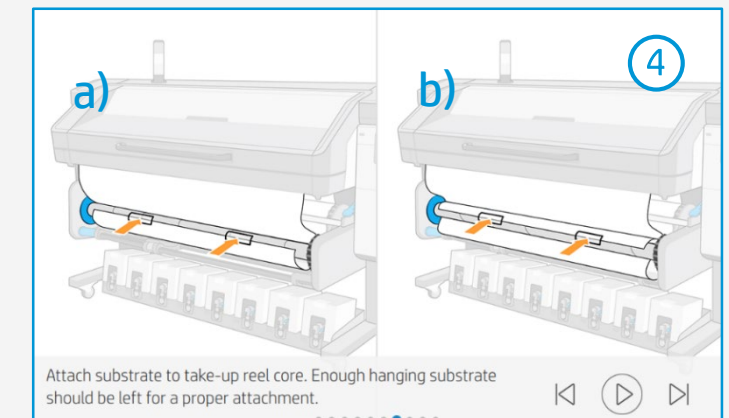
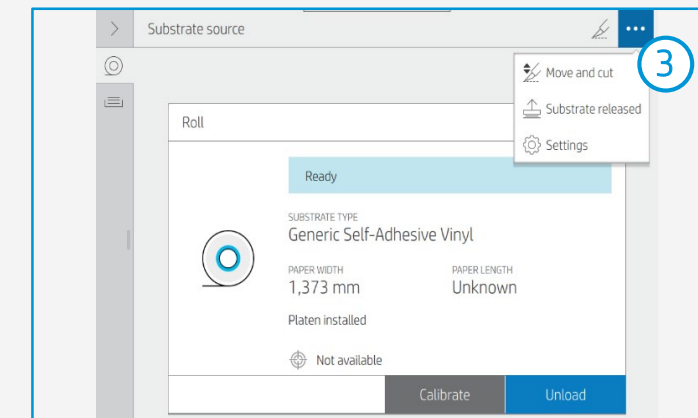
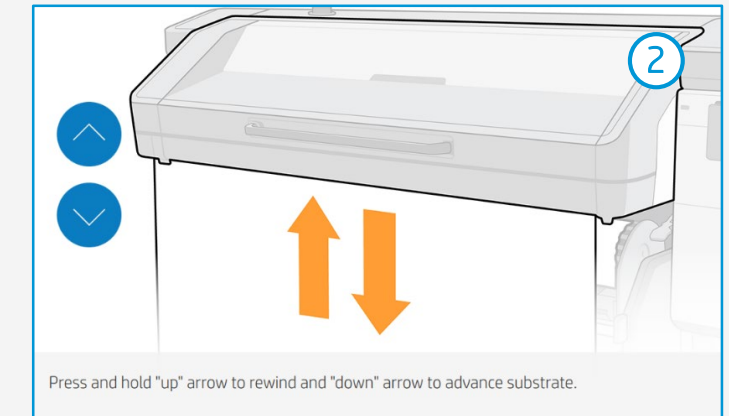
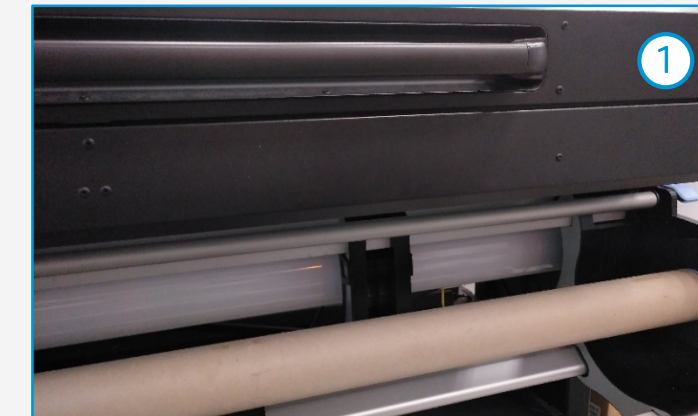

TIP: For long jobs, connect the substrate to the take-up-reel (TUR). For tiling applications, connect the TUR before the start of printing.

How to do wallcoverings

The printing process

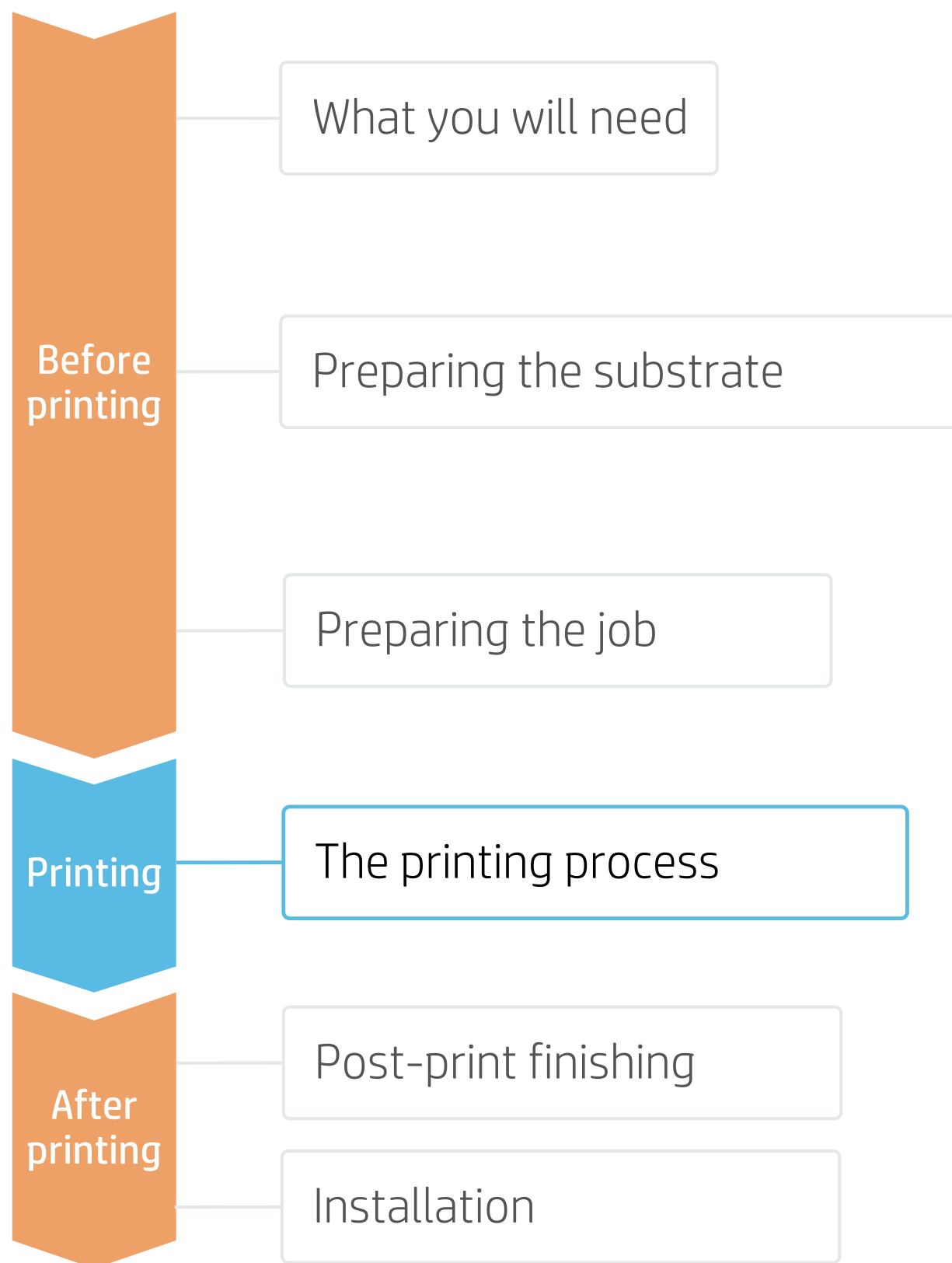

1. **Load the roll**
By default, this is in automatic mode.

2. **Select the right substrate preset**
If your substrate is new or not in the list, select a **generic** from **Paper and Wallcovering**.

3. **Attach the substrate to the TUR**
Follow the instructions shown on the previous page.

4. **Check print IQ status**
Perform the printhead nozzle check and printhead alignment.

5. **Send job to print from RIP**
Check the RIP has **synchronized** the loaded substrate with the printer.
Select the correct printmode and set any other settings (copies, placements, etc.).
Click **Send to print**.

6. **Cut & retrieve printed roll**
This can be done in automatic mode or manually.

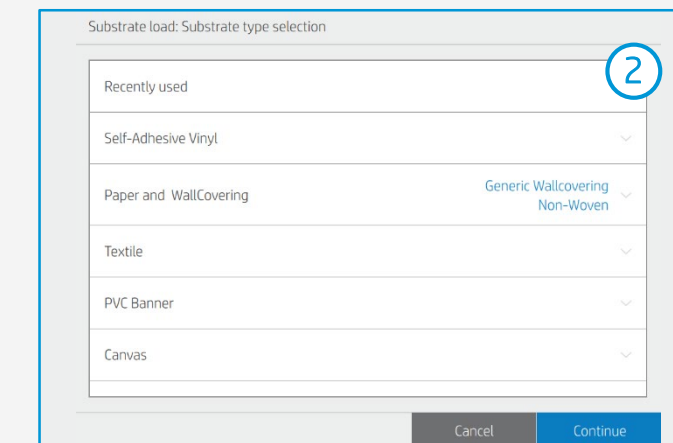
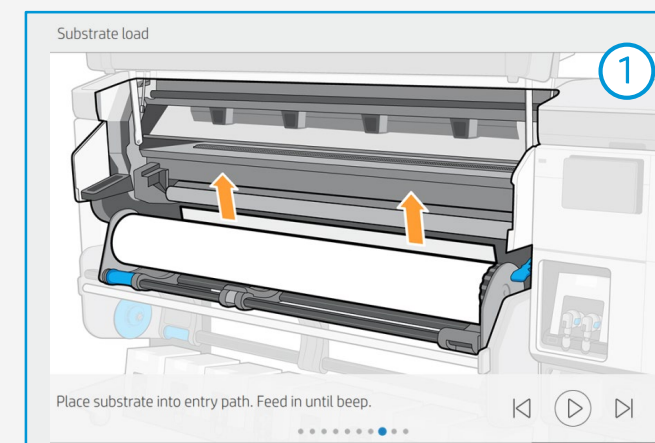

TIP: If new settings are required, you can **Add new substrate**, or **clone** the generic and modify it.

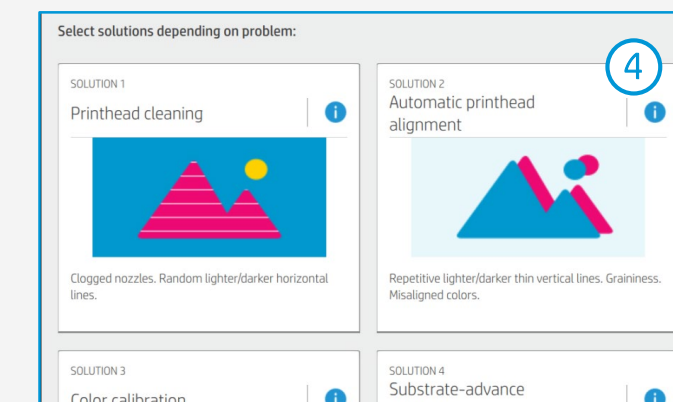

TIP: When using highly textured substrates, perform these diagnostics on white self-adhesive vinyl before loading your wallcovering substrate.

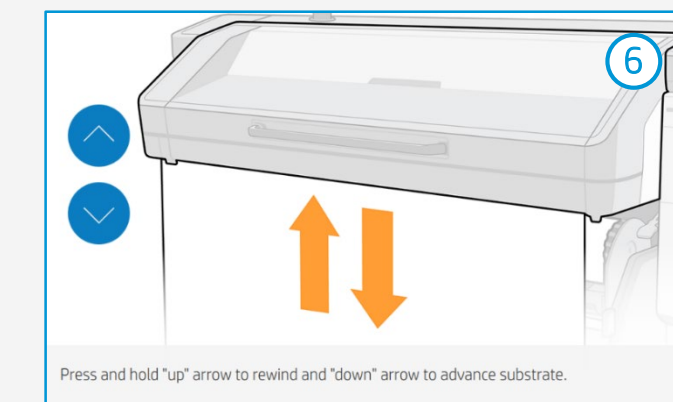
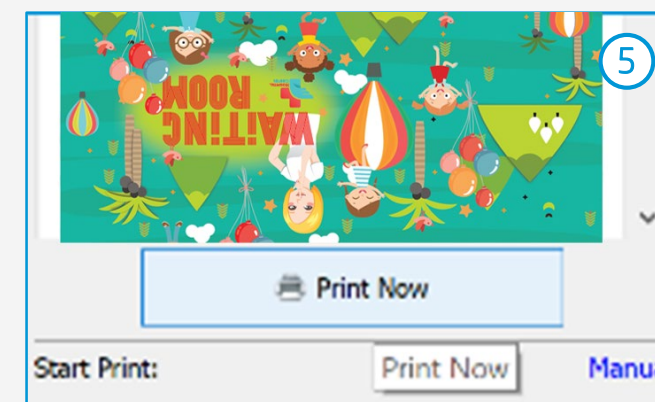

TIP: Before cutting the printed job, advance the substrate so you protect the printed roll when unloaded.

How to do wallcoverings

Once printed, what else?

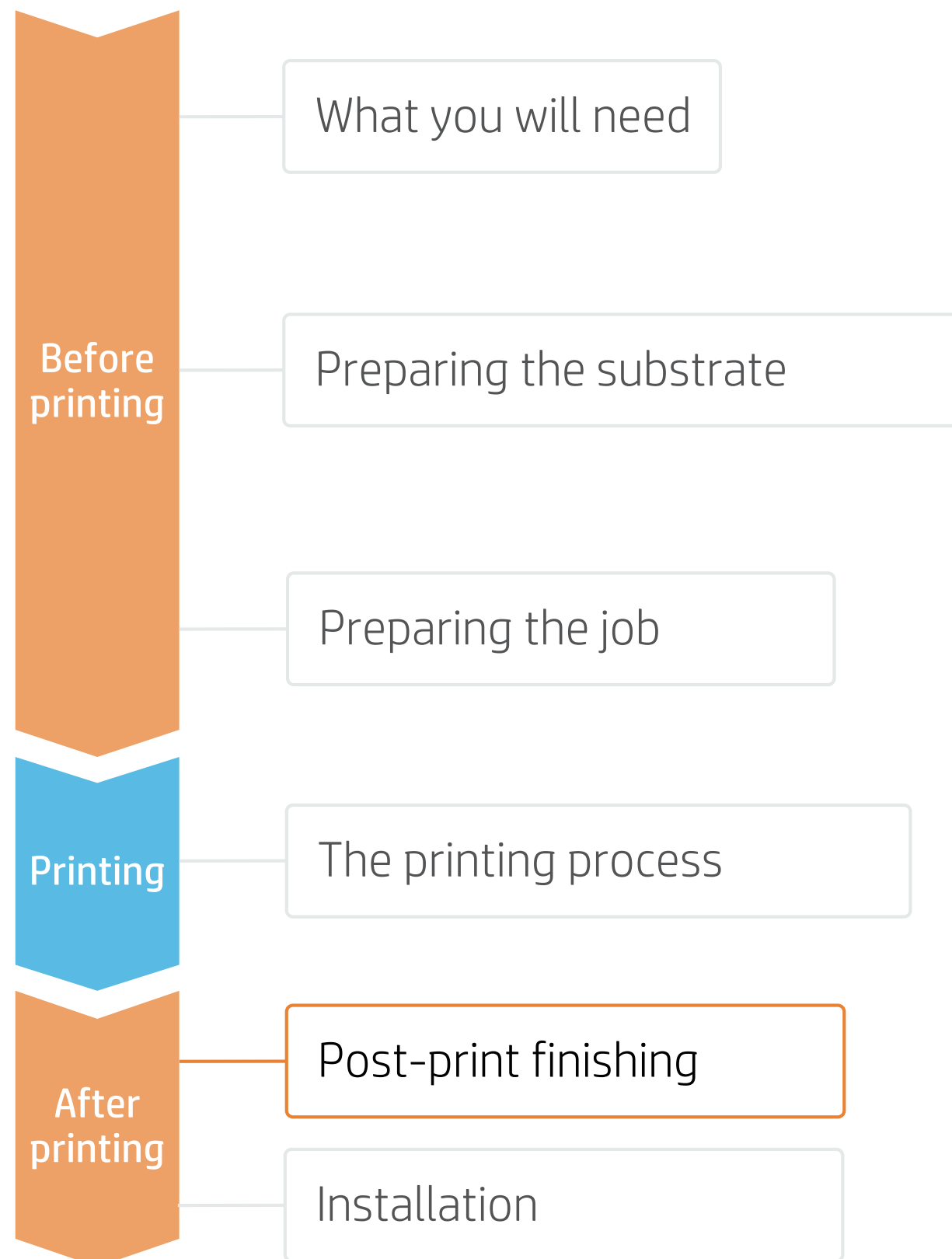

1. Liquid lamination (optional)

Wallcoverings printed with HP Latex 700 and HP latex 800 series printers can be claimed to be up to “washable” standard according to EN 233 (2016), without any extra protection.

Liquid lamination is recommended when high levels of serviceability are required, that is in some commercial applications like hotels or restaurants.

It can be applied in 2 ways:

1. With a liquid laminator, prior to cutting tiles.
2. Manually with a roller, with tiles lying flat or after installation on the wall.

TIP: Marabu Clearshield and Dreamscape Dreamguard are some of the liquid topcoats you can find on the market.

NOTE: Cleanability performance is dependent on the substrate as well as the printmode used.

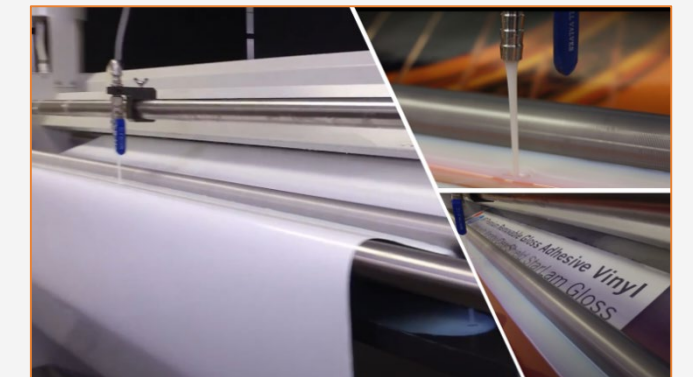

2. Cut

To cut the graphics automatically, you can use XY cutters (i.e. Fotoba) or flat bed contour cutters.



3. Rolling and packing

Tiles are normally rolled and packed, grouped by jobs.



How to do wallcoverings

Once printed, what else?

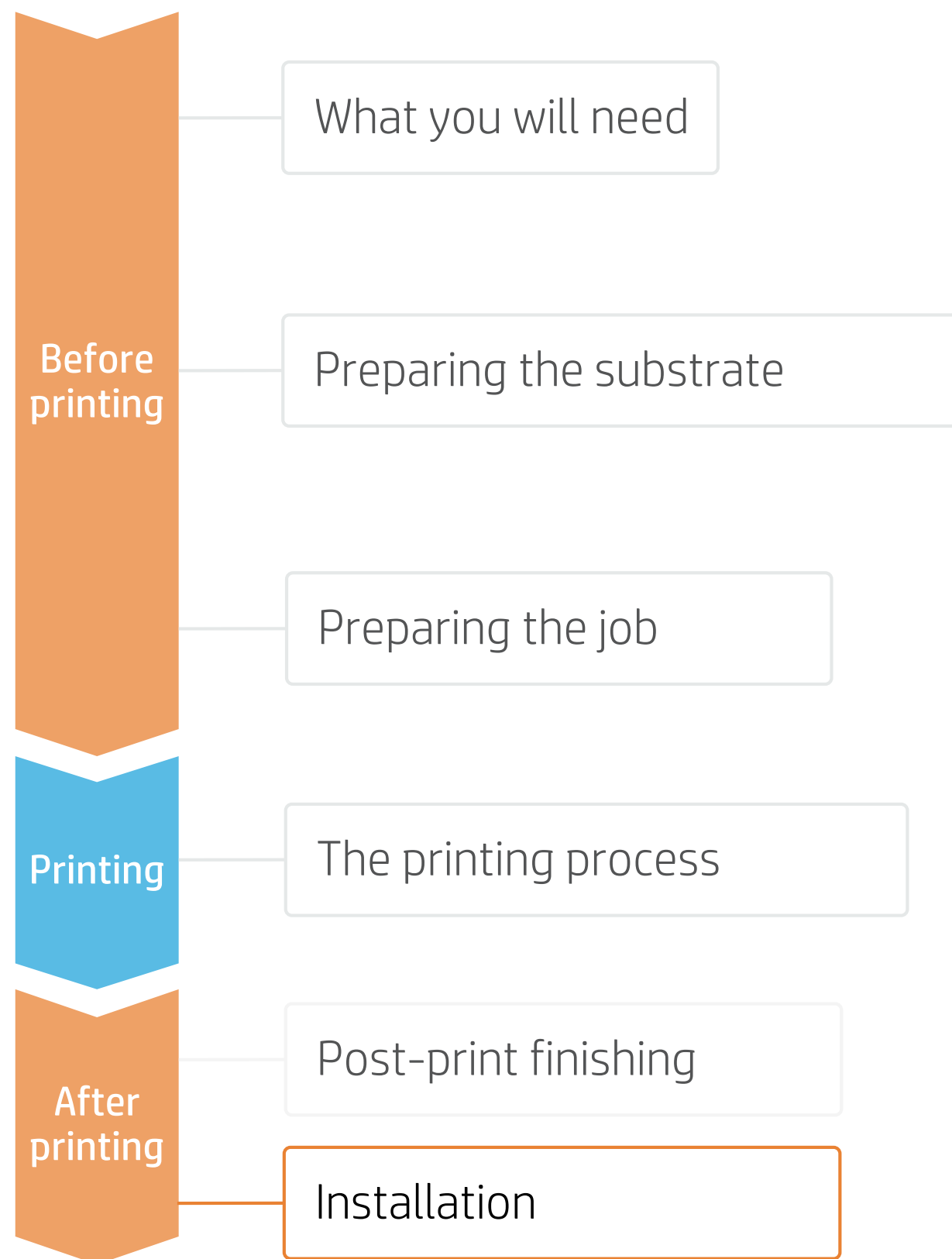

1. Prior to installation

The base surface should be carefully prepared:

- **Remove old wallpaper and remains of old paste** - try using a squirting bottle with water and a few squirts of washing up liquid.
- **Remove peeling paint remnants.**
- **Re-plaster** and **sand down** any rough surfaces
- **Clean** with a damp cloth, leaving walls to dry completely before wallpapering



2. Paste application

The paste application technique will depend on the type of substrate you use.

a) With regular wallcovering substrates:

1. Paste the wall
2. Paste the substrate

b) With pre-pasted substrates:

1. Soak the substrate in water
2. Spray water on the wall

Apply the graphic using a squeegee with a low friction sleeve on the edge or a smoothing brush.

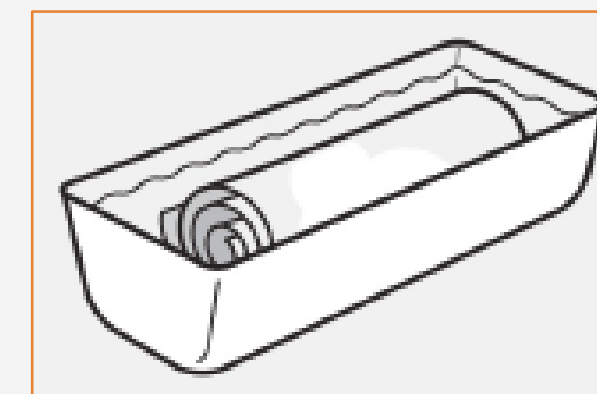

How to do wallcoverings

Once printed, what else?

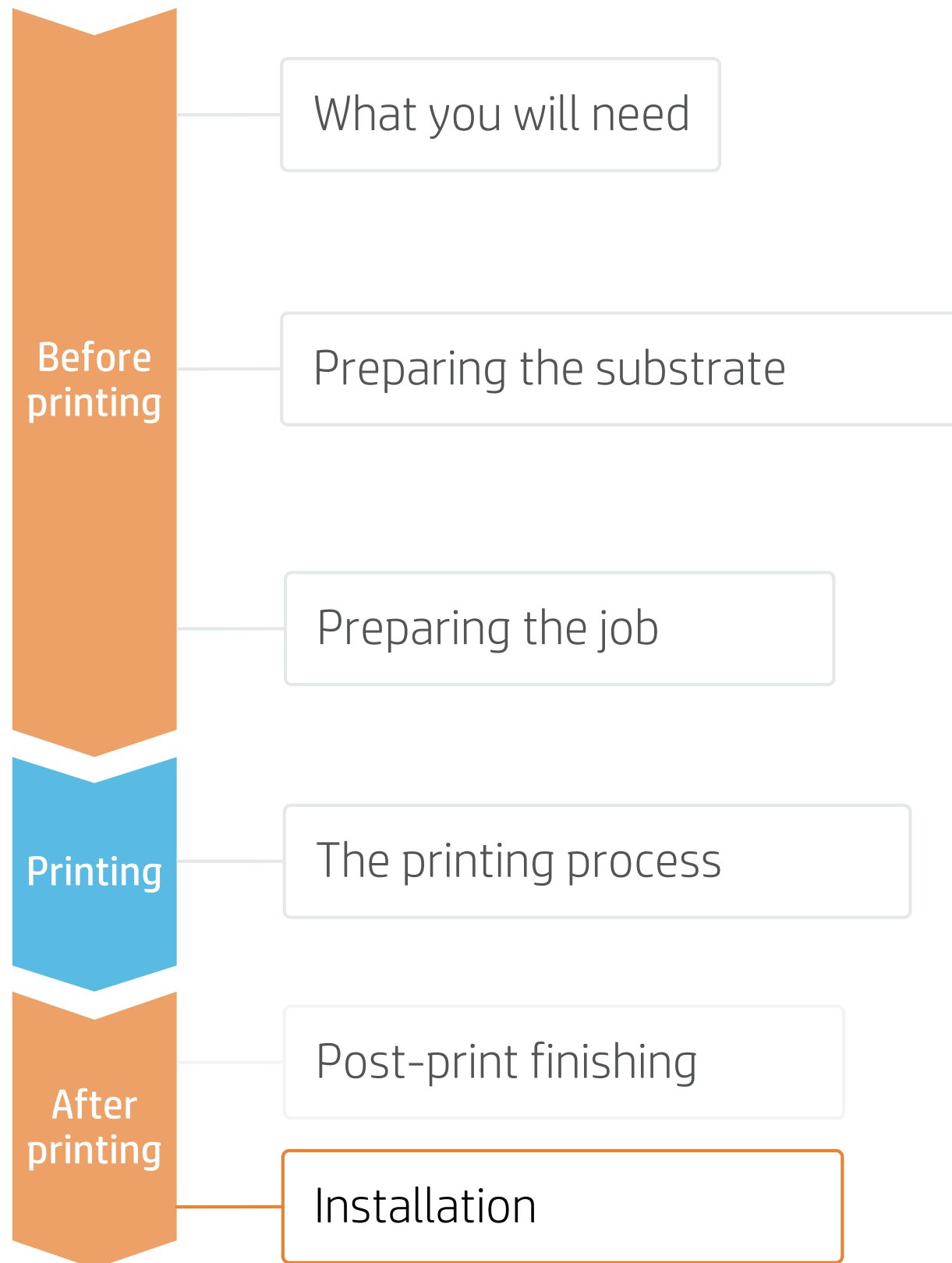

3. Tiles installation

With the help of a leveler and a ruler, mark where to install the first tile.

Position the tile with your hands, and smooth down the substrate with a brush or spatula. Avoid damaging the graphic or causing scratches.

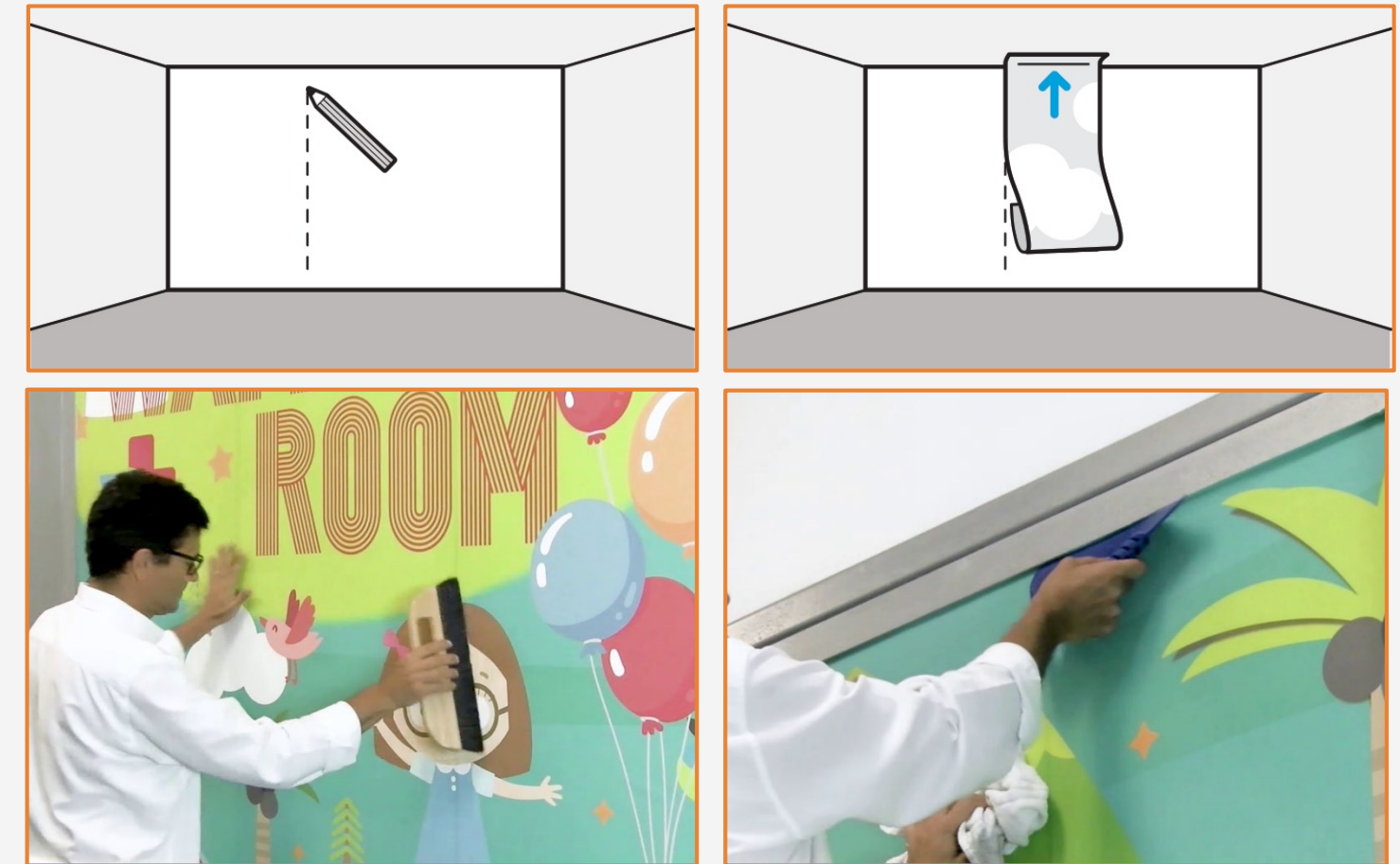

4. Seams: Overlap or double-seam cut

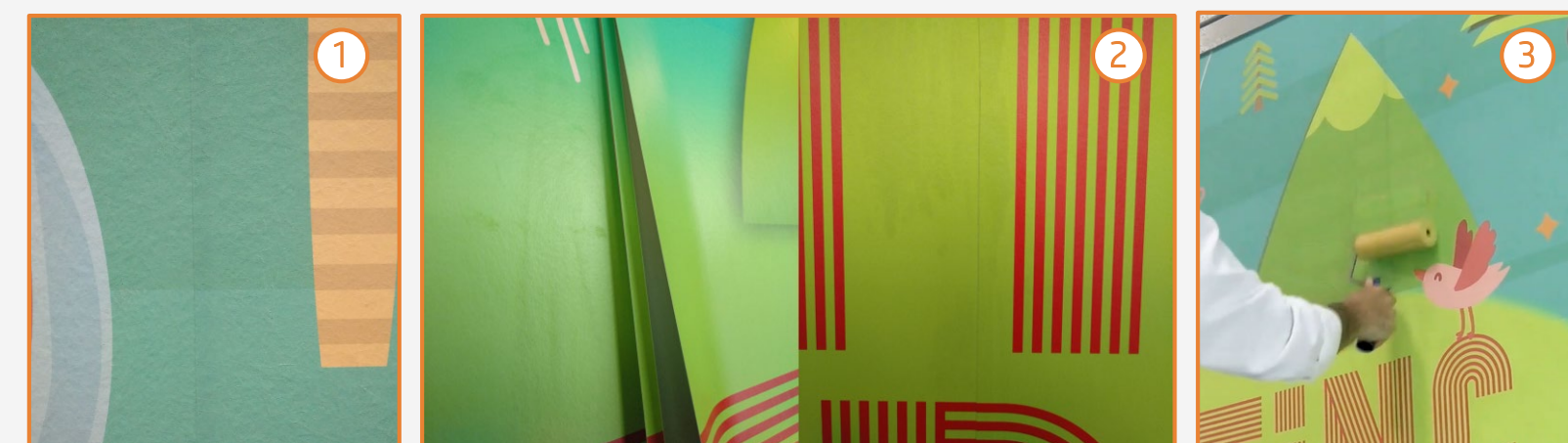

The next tile is placed overlapping the first tile. The seam can be left as overlapped (1) or seamless with a double-cut (2). Smooth the seams with a roller (3).

How to do wallcoverings

Remarks

- HP Latex Technology provides great versatility for printing the widest portfolio of wallcovering types and surfaces.
- Get color consistency and length accuracy between tiles.
- The new HP Latex inks are ideal for safe indoor applications. The newest HP Latex Inks are UL ECOLOGO and UL GREENGUARD GOLD certified, and conform to the Zero Discharge of Hazard Chemicals (ZDHC) manufacturing restricted substances list v1.1.

Learn more at:

- [HP Latex Knowledge Center](#)
- [Learn with HP](#)

Certifications:

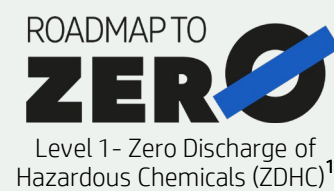

Inks meet stringent health and environmental criteria²



Unrestricted, full room. No-wait installation or lamination³

¹Zero Discharge of Hazardous Chemicals. Applicable to HP Latex Inks. The ZDHC Roadmap to Zero Level 1 demonstrates that an ink conforms to or meets the standards of the ZDHC Manufacturing Restricted Substances List (ZDHC MRSL) 1.1, a list of chemical substances banned from intentional use during production. ZDHC is an organization dedicated to eliminating hazardous chemicals and implementing sustainable chemicals in the leather, textile, and synthetics sectors. The Roadmap to Zero Program is a multi-stakeholder organization which includes brands, value chain affiliates, and associates, that work collaboratively to implement responsible chemical management practices. See roadmaptozero.com.

²Applicable to R Series and 700/800 Printer series HP Latex Inks. UL ECOLOGO® Certification to UL 2801 demonstrates that an ink meets a range of multi-attribute, lifecycle-based stringent criteria related to human health and environmental considerations (see ul.com/EL). HP is the only printing company with UL ECOLOGO® Certified inks in the "Printing Inks and Graphics Film" product category, see spot.ul.com/main-app/products/catalog/.

³Applicable to HP Latex Inks. UL GREENGUARD Gold Certification to UL 2818 demonstrates that products are certified to UL's GREENGUARD standards for low chemical emissions into indoor air during product usage. Unrestricted room size—full decorated room, 33.4 m² (360 ft²) in an office environment, 94.6 m² (1,018 ft²) in a classroom environment. For more information, visit ul.com/gg or greenguard.org.

In partnership with:



